

# NX3L2G384

## Dual low-ohmic single-pole single-throw analog switch

Rev. 03 — 28 August 2009

Product data sheet

### 1. General description

---

The NX3L2G384 provides two low-ohmic single pole single throw analog switch functions. Each switch has two input/output terminals (nY and nZ) and an active LOW enable input (n $\bar{E}$ ). When pin n $\bar{E}$  is HIGH, the analog switch is turned off.

Schmitt-trigger action at the enable input (n $\bar{E}$ ) makes the circuit tolerant to slower input rise and fall times across the entire  $V_{CC}$  range from 1.4 V to 4.3 V.

The NX3L2G384 allows signals with amplitude up to  $V_{CC}$  to be transmitted from nY to nZ; or from nZ to nY. Its low ON resistance (0.5  $\Omega$ ) and flatness (0.13  $\Omega$ ) ensures minimal attenuation and distortion of transmitted signals.

### 2. Features

---

- Wide supply voltage range from 1.4 V to 4.3 V
- Very low ON resistance (peak):
  - ◆ 1.6  $\Omega$  (typical) at  $V_{CC} = 1.4$  V
  - ◆ 1.0  $\Omega$  (typical) at  $V_{CC} = 1.65$  V
  - ◆ 0.55  $\Omega$  (typical) at  $V_{CC} = 2.3$  V
  - ◆ 0.50  $\Omega$  (typical) at  $V_{CC} = 2.7$  V
  - ◆ 0.50  $\Omega$  (typical) at  $V_{CC} = 4.3$  V
- High noise immunity
- ESD protection:
  - ◆ HBM JESD22-A114E Class 3A exceeds 7500 V
  - ◆ MM JESD22-A115-A exceeds 200 V
  - ◆ CDM AEC-Q100-011 revision B exceeds 1000 V
- CMOS low-power consumption
- Latch-up performance exceeds 100 mA per JESD 78 Class II Level A
- Direct interface with TTL levels at 3.0 V
- Control input accepts voltages above the supply voltage
- High current handling capability (350 mA continuous current under 3.3 V supply)
- Specified from  $-40$  °C to  $+85$  °C and from  $-40$  °C to  $+125$  °C

### 3. Applications

---

- Cell phone
- PDA
- Portable media player

## 4. Ordering information

**Table 1. Ordering information**

Type number	Package			Version
	Temperature range	Name	Description	
NX3L2G384GT	-40 °C to +125 °C	XSON8	plastic extremely thin small outline package; no leads; 8 terminals; body 1 × 1.95 × 0.5 mm	SOT833-1
NX3L2G384GD	-40 °C to +125 °C	XSON8U	plastic extremely thin small outline package; no leads; 8 terminals; UTLP based; body 3 × 2 × 0.5 mm	SOT996-2
NX3L2G384GM	-40 °C to +125 °C	XQFN8U	plastic extremely thin quad flat package; no leads; 8 terminals; body 1.6 × 1.6 × 0.5 mm	SOT902-1

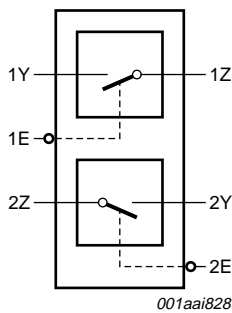
## 5. Marking

**Table 2. Marking codes<sup>[1]</sup>**

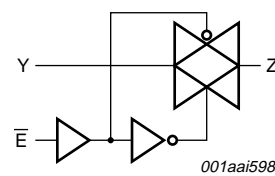
Type number	Marking code
NX3L2G384GT	ML2
NX3L2G384GD	ML2
NX3L2G384GM	ML2

[1] The pin 1 indicator is located on the lower left corner of the device, below the marking code.

## 6. Functional diagram



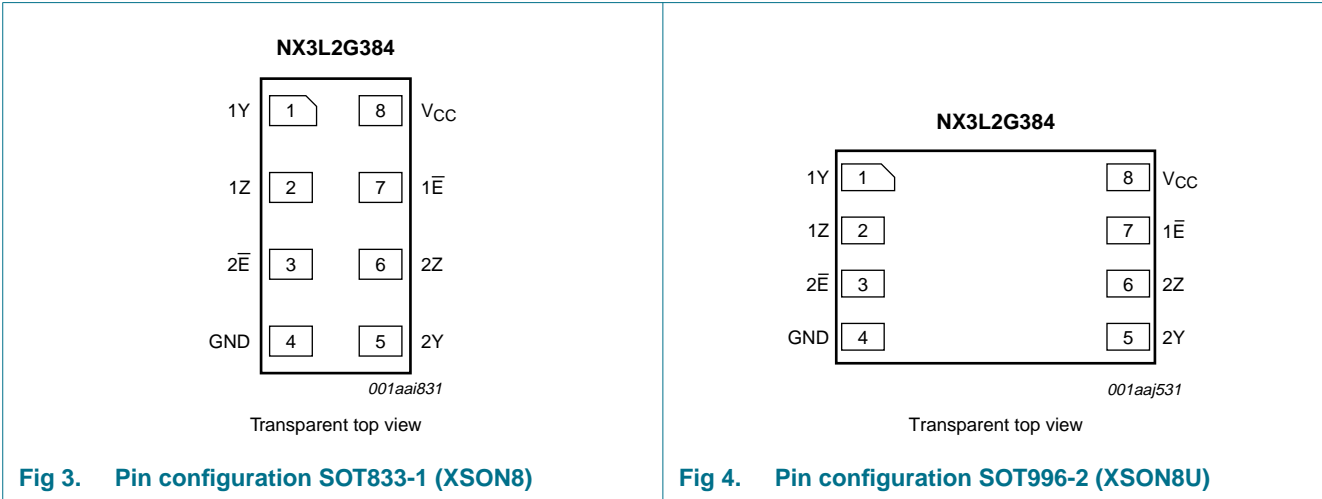
**Fig 1. Logic symbol**



**Fig 2. Logic diagram (one switch)**

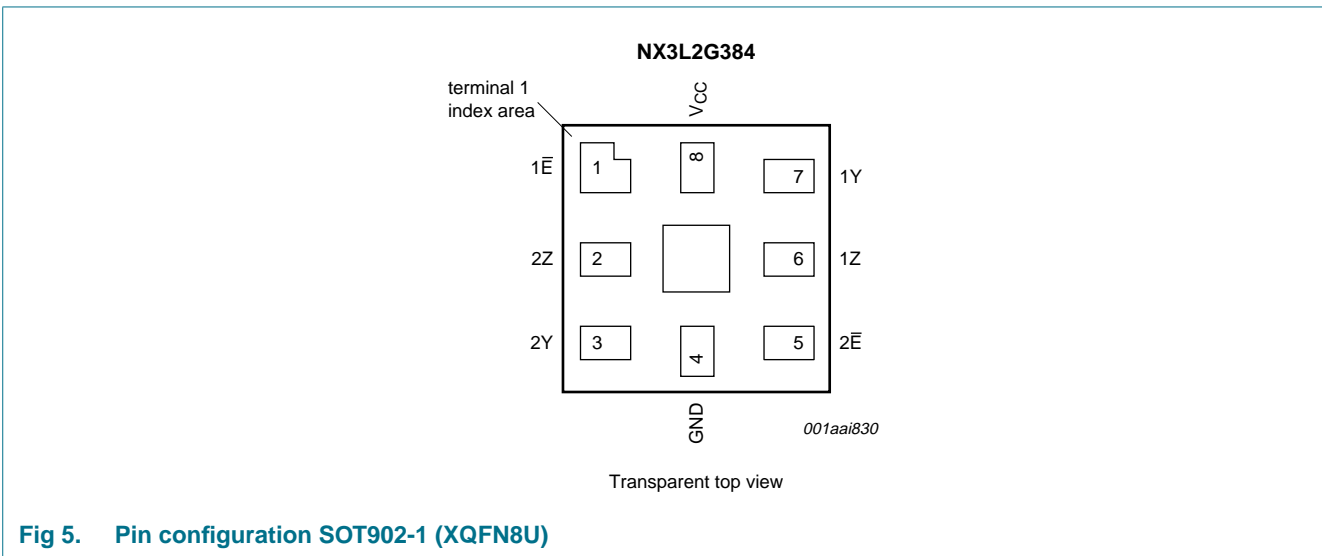
**7. Pinning information**

**7.1 Pinning**



**Fig 3. Pin configuration SOT833-1 (XSON8)**

**Fig 4. Pin configuration SOT996-2 (XSON8U)**



**Fig 5. Pin configuration SOT902-1 (XQFN8U)**

## 7.2 Pin description

**Table 3.** Pin description

Symbol	Pin		Description
	SOT833-1 and SOT996-2	SOT902-1	
1Y, 2Y	1, 5	7, 3	independent input or output
1Z, 2Z	2, 6	6, 2	independent input or output
GND	4	4	ground (0 V)
1 $\bar{E}$ , 2 $\bar{E}$	7, 3	1, 5	enable input (active LOW)
V <sub>CC</sub>	8	8	supply voltage

## 8. Functional description

**Table 4.** Function table<sup>[1]</sup>

Input n $\bar{E}$	Switch
L	ON-state
H	OFF-state

- [1] H = HIGH voltage level;  
L = LOW voltage level.

## 9. Limiting values

**Table 5.** Limiting values

In accordance with the Absolute Maximum Rating System (IEC 60134). Voltages are referenced to GND (ground = 0 V).

Symbol	Parameter	Conditions	Min	Max	Unit
V <sub>CC</sub>	supply voltage		-0.5	+4.6	V
V <sub>I</sub>	input voltage	enable input n $\bar{E}$	<sup>[1]</sup> -0.5	+4.6	V
V <sub>SW</sub>	switch voltage		<sup>[2]</sup> -0.5	V <sub>CC</sub> + 0.5	V
I <sub>IK</sub>	input clamping current	V <sub>I</sub> < -0.5 V	-50	-	mA
I <sub>SK</sub>	switch clamping current	V <sub>I</sub> < -0.5 V or V <sub>I</sub> > V <sub>CC</sub> + 0.5 V	-	±50	mA
I <sub>SW</sub>	switch current	V <sub>SW</sub> > -0.5 V or V <sub>SW</sub> < V <sub>CC</sub> + 0.5 V; source or sink current	-	±350	mA
		V <sub>SW</sub> > -0.5 V or V <sub>SW</sub> < V <sub>CC</sub> + 0.5 V; pulsed at 1 ms duration, < 10 % duty cycle; peak current	-	±500	mA
T <sub>stg</sub>	storage temperature		-65	+150	°C
P <sub>tot</sub>	total power dissipation	T <sub>amb</sub> = -40 °C to +125 °C	<sup>[3]</sup> -	250	mW

- [1] The minimum input voltage rating may be exceeded if the input current rating is observed.  
 [2] The minimum and maximum switch voltage ratings may be exceeded if the switch clamping current rating is observed but may not exceed 4.6 V.  
 [3] For XSON8, XSON8U and XQFN8U packages: above 118 °C the value of P<sub>tot</sub> derates linearly with 7.8 mW/K.

## 10. Recommended operating conditions

**Table 6. Recommended operating conditions**

Symbol	Parameter	Conditions	Min	Typ	Max	Unit
$V_{CC}$	supply voltage		1.4	-	4.3	V
$V_I$	input voltage	enable input $n\bar{E}$	0	-	4.3	V
$V_{SW}$	switch voltage		[1] 0	-	$V_{CC}$	V
$T_{amb}$	ambient temperature		-40	-	+125	°C
$\Delta t/\Delta V$	input transition rise and fall rate	$V_{CC} = 1.4\text{ V to }4.3\text{ V}$	[2] -	-	200	ns/V

[1] To avoid sinking GND current from terminal nZ when switch current flows in terminal nY, the voltage drop across the bidirectional switch must not exceed 0.4 V. If the switch current flows into terminal nZ, no GND current will flow from terminal nY. In this case, there is no limit for the voltage drop across the switch.

[2] Applies to control signal levels.

## 11. Static characteristics

**Table 7. Static characteristics**

At recommended operating conditions; voltages are referenced to GND (ground 0 V).

Symbol	Parameter	Conditions	25 °C			-40 °C to +125 °C			Unit
			Min	Typ	Max	Min	Max (85 °C)	Max (125 °C)	
$V_{IH}$	HIGH-level input voltage	$V_{CC} = 1.4\text{ V to }1.95\text{ V}$	$0.65V_{CC}$	-	-	$0.65V_{CC}$	-	-	V
		$V_{CC} = 2.3\text{ V to }2.7\text{ V}$	1.7	-	-	1.7	-	-	V
		$V_{CC} = 2.7\text{ V to }3.6\text{ V}$	2.0	-	-	2.0	-	-	V
		$V_{CC} = 3.6\text{ V to }4.3\text{ V}$	$0.7V_{CC}$	-	-	$0.7V_{CC}$	-	-	V
$V_{IL}$	LOW-level input voltage	$V_{CC} = 1.4\text{ V to }1.95\text{ V}$	-	-	$0.35V_{CC}$	-	$0.35V_{CC}$	$0.35V_{CC}$	V
		$V_{CC} = 2.3\text{ V to }2.7\text{ V}$	-	-	0.7	-	0.7	0.7	V
		$V_{CC} = 2.7\text{ V to }3.6\text{ V}$	-	-	0.8	-	0.8	0.8	V
		$V_{CC} = 3.6\text{ V to }4.3\text{ V}$	-	-	$0.3V_{CC}$	-	$0.3V_{CC}$	$0.3V_{CC}$	V
$I_I$	input leakage current	enable input $n\bar{E}$ ; $V_I = \text{GND to }4.3\text{ V}$ ; $V_{CC} = 1.4\text{ V to }4.3\text{ V}$	-	-	-	-	$\pm 0.5$	$\pm 1$	$\mu\text{A}$
$I_{S(OFF)}$	OFF-state leakage current	nY port; see <a href="#">Figure 6</a>							
		$V_{CC} = 1.4\text{ V to }3.6\text{ V}$	-	-	$\pm 5$	-	$\pm 50$	$\pm 500$	nA
		$V_{CC} = 3.6\text{ V to }4.3\text{ V}$	-	-	$\pm 10$	-	$\pm 50$	$\pm 500$	nA
$I_{S(ON)}$	ON-state leakage current	nZ port; see <a href="#">Figure 7</a>							
		$V_{CC} = 1.4\text{ V to }3.6\text{ V}$	-	-	$\pm 5$	-	$\pm 50$	$\pm 500$	nA
		$V_{CC} = 3.6\text{ V to }4.3\text{ V}$	-	-	$\pm 10$	-	$\pm 50$	$\pm 500$	nA
$I_{CC}$	supply current	$V_I = V_{CC}\text{ or GND}$ ; $V_{SW} = \text{GND or }V_{CC}$							
		$V_{CC} = 3.6\text{ V}$	-	-	100	-	690	6000	nA
		$V_{CC} = 4.3\text{ V}$	-	-	150	-	800	7000	nA

**Table 7. Static characteristics ...continued**

At recommended operating conditions; voltages are referenced to GND (ground 0 V).

Symbol	Parameter	Conditions	25 °C			-40 °C to +125 °C			Unit
			Min	Typ	Max	Min	Max (85 °C)	Max (125 °C)	
$C_I$	input capacitance		-	1.0	-	-	-	-	pF
$C_{S(OFF)}$	OFF-state capacitance		-	35	-	-	-	-	pF
$C_{S(ON)}$	ON-state capacitance		-	110	-	-	-	-	pF

**11.1 Test circuits**

$V_I = 0.3 \text{ V or } V_{CC} - 0.3 \text{ V}; V_O = V_{CC} - 0.3 \text{ V or } 0.3 \text{ V}.$

**Fig 6. Test circuit for measuring OFF-state leakage current**

$V_I = 0.3 \text{ V or } V_{CC} - 0.3 \text{ V}; V_O = \text{open circuit}.$

**Fig 7. Test circuit for measuring ON-state leakage current**

**11.2 ON resistance**

**Table 8. ON resistance**

At recommended operating conditions; voltages are referenced to GND (ground = 0 V); for graphs see [Figure 9](#) to [Figure 15](#).

Symbol	Parameter	Conditions	-40 °C to +85 °C			-40 °C to +125 °C		Unit
			Min	Typ <sup>[1]</sup>	Max	Min	Max	
$R_{ON(peak)}$	ON resistance (peak)	$V_I = \text{GND to } V_{CC};$ $I_{SW} = 100 \text{ mA};$ see <a href="#">Figure 8</a>						
		$V_{CC} = 1.4 \text{ V}$	-	1.6	3.7	-	4.1	$\Omega$
		$V_{CC} = 1.65 \text{ V}$	-	1.0	1.6	-	1.7	$\Omega$
		$V_{CC} = 2.3 \text{ V}$	-	0.55	0.8	-	0.9	$\Omega$
		$V_{CC} = 2.7 \text{ V}$	-	0.5	0.75	-	0.9	$\Omega$
		$V_{CC} = 4.3 \text{ V}$	-	0.5	0.75	-	0.9	$\Omega$

**Table 8. ON resistance ...continued**

At recommended operating conditions; voltages are referenced to GND (ground = 0 V); for graphs see [Figure 9](#) to [Figure 15](#).

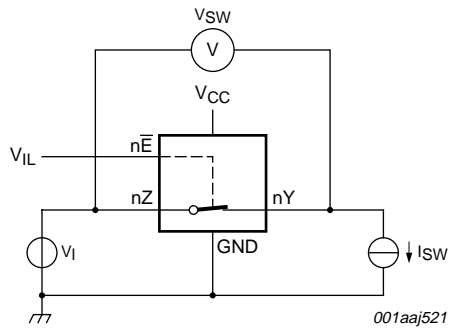
Symbol	Parameter	Conditions	-40 °C to +85 °C			-40 °C to +125 °C		Unit
			Min	Typ <sup>[1]</sup>	Max	Min	Max	
$\Delta R_{ON}$	ON resistance mismatch between channels	$V_I = \text{GND to } V_{CC};$ $I_{SW} = 100 \text{ mA}$						
		$V_{CC} = 1.4 \text{ V}$	-	0.04	0.3	-	0.3	$\Omega$
		$V_{CC} = 1.65 \text{ V}$	-	0.04	0.2	-	0.3	$\Omega$
		$V_{CC} = 2.3 \text{ V}$	-	0.02	0.08	-	0.1	$\Omega$
		$V_{CC} = 2.7 \text{ V}$	-	0.02	0.075	-	0.1	$\Omega$
		$V_{CC} = 4.3 \text{ V}$	-	0.02	0.075	-	0.1	$\Omega$
$R_{ON(\text{flat})}$	ON resistance (flatness)	$V_I = \text{GND to } V_{CC};$ $I_{SW} = 100 \text{ mA}$						
		$V_{CC} = 1.4 \text{ V}$	-	1.0	3.3	-	3.6	$\Omega$
		$V_{CC} = 1.65 \text{ V}$	-	0.5	1.2	-	1.3	$\Omega$
		$V_{CC} = 2.3 \text{ V}$	-	0.15	0.3	-	0.35	$\Omega$
		$V_{CC} = 2.7 \text{ V}$	-	0.13	0.3	-	0.35	$\Omega$
		$V_{CC} = 4.3 \text{ V}$	-	0.2	0.4	-	0.45	$\Omega$

[1] Typical values are measured at  $T_{\text{amb}} = 25 \text{ }^\circ\text{C}$ .

[2] Measured at identical  $V_{CC}$ , temperature and input voltage.

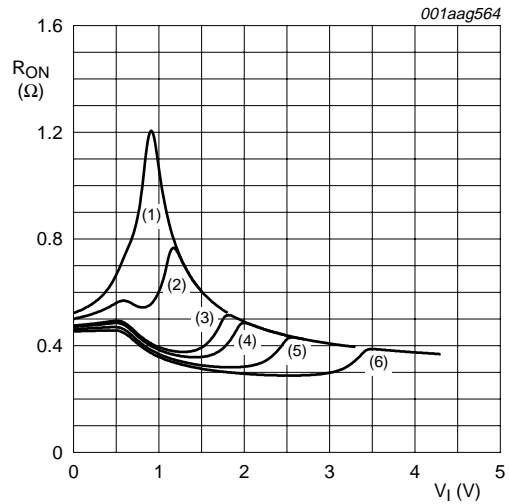
[3] Flatness is defined as the difference between the maximum and minimum value of ON resistance measured at identical  $V_{CC}$  and temperature.

**11.3 ON resistance test circuit and graphs**



$R_{ON} = V_{SW} / I_{SW}$ .

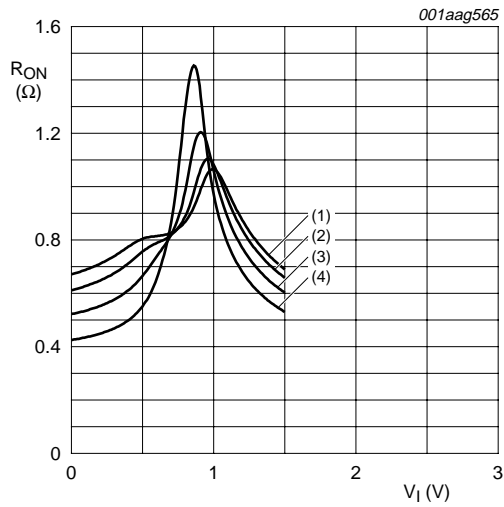
**Fig 8. Test circuit for measuring ON resistance**



- (1)  $V_{CC} = 1.5 \text{ V.}$
- (2)  $V_{CC} = 1.8 \text{ V.}$
- (3)  $V_{CC} = 2.5 \text{ V.}$
- (4)  $V_{CC} = 2.7 \text{ V.}$
- (5)  $V_{CC} = 3.3 \text{ V.}$
- (6)  $V_{CC} = 4.3 \text{ V.}$

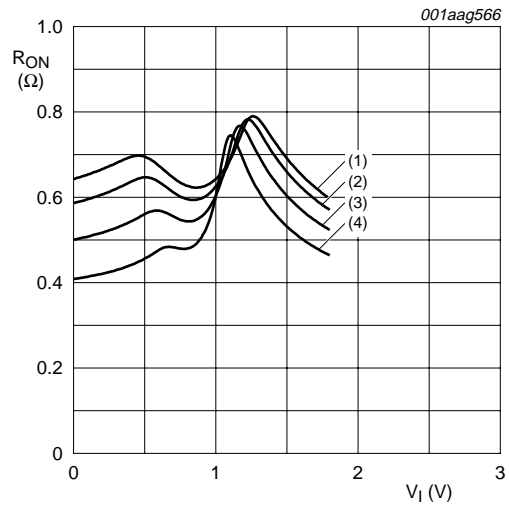
Measured at  $T_{amb} = 25 \text{ }^\circ\text{C.}$

**Fig 9. Typical ON resistance as a function of input voltage**



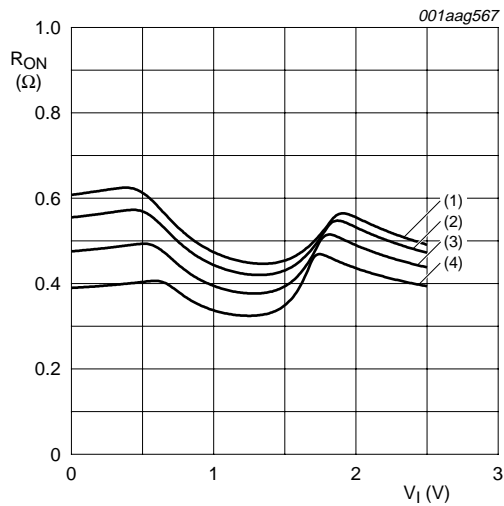
- (1)  $T_{amb} = 125\text{ }^{\circ}\text{C}.$
- (2)  $T_{amb} = 85\text{ }^{\circ}\text{C}.$
- (3)  $T_{amb} = 25\text{ }^{\circ}\text{C}.$
- (4)  $T_{amb} = -40\text{ }^{\circ}\text{C}.$

**Fig 10. ON resistance as a function of input voltage;**  
 $V_{CC} = 1.5\text{ V}$



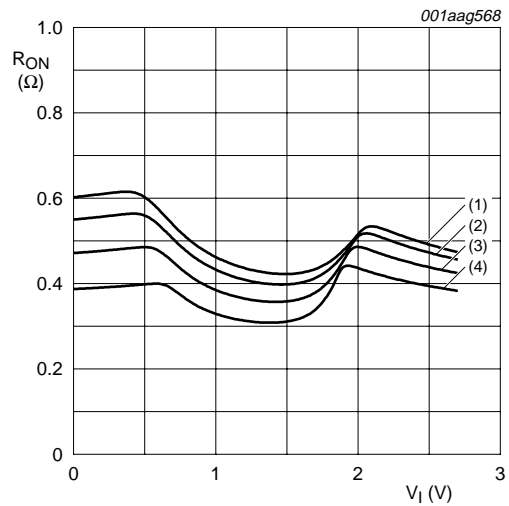
- (1)  $T_{amb} = 125\text{ }^{\circ}\text{C}.$
- (2)  $T_{amb} = 85\text{ }^{\circ}\text{C}.$
- (3)  $T_{amb} = 25\text{ }^{\circ}\text{C}.$
- (4)  $T_{amb} = -40\text{ }^{\circ}\text{C}.$

**Fig 11. ON resistance as a function of input voltage;**  
 $V_{CC} = 1.8\text{ V}$



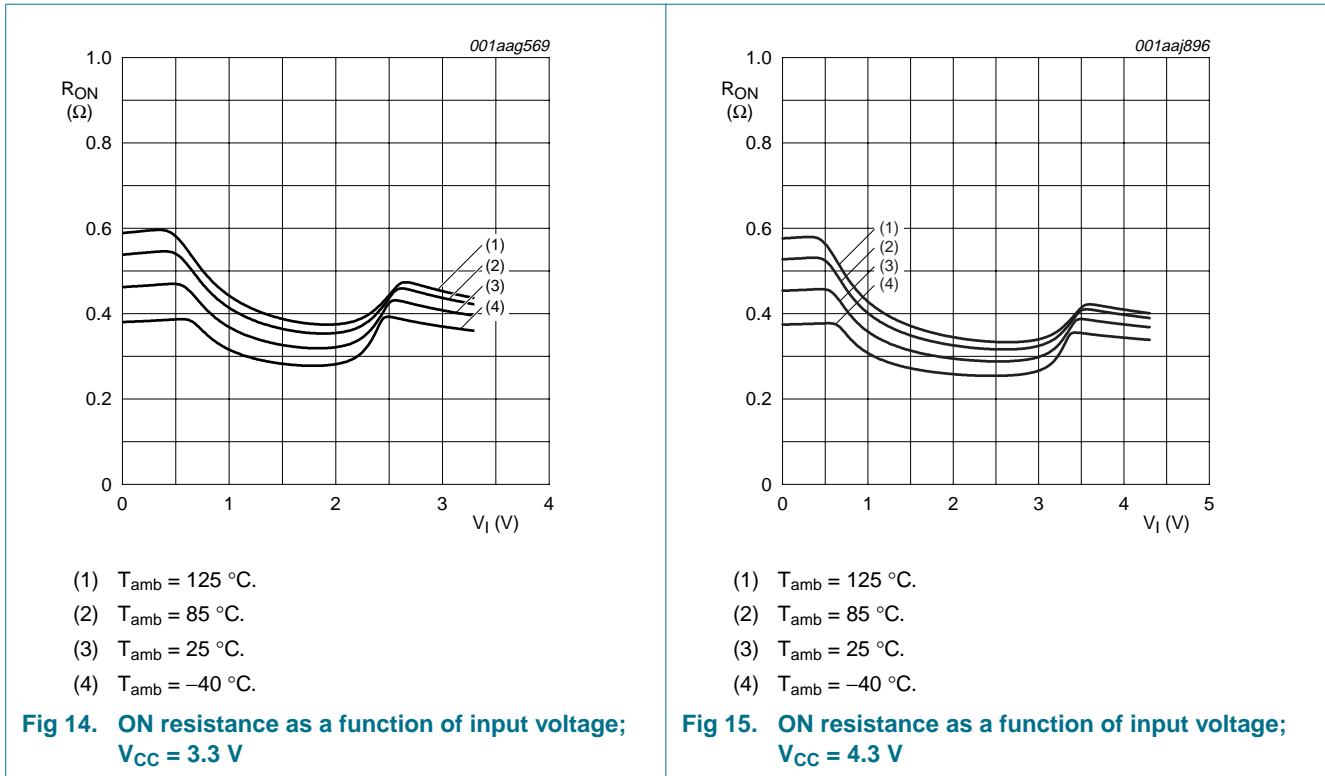
- (1)  $T_{amb} = 125\text{ }^{\circ}\text{C}.$
- (2)  $T_{amb} = 85\text{ }^{\circ}\text{C}.$
- (3)  $T_{amb} = 25\text{ }^{\circ}\text{C}.$
- (4)  $T_{amb} = -40\text{ }^{\circ}\text{C}.$

**Fig 12. ON resistance as a function of input voltage;**  
 $V_{CC} = 2.5\text{ V}$



- (1)  $T_{amb} = 125\text{ }^{\circ}\text{C}.$
- (2)  $T_{amb} = 85\text{ }^{\circ}\text{C}.$
- (3)  $T_{amb} = 25\text{ }^{\circ}\text{C}.$
- (4)  $T_{amb} = -40\text{ }^{\circ}\text{C}.$

**Fig 13. ON resistance as a function of input voltage;**  
 $V_{CC} = 2.7\text{ V}$



## 12. Dynamic characteristics

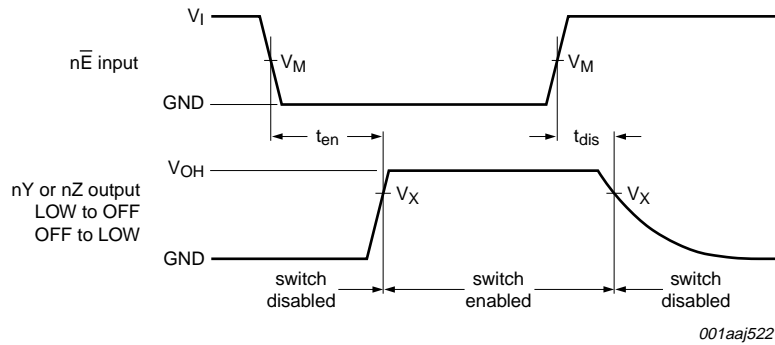
**Table 9. Dynamic characteristics**

At recommended operating conditions; voltages are referenced to GND (ground = 0 V); for load circuit see [Figure 17](#).

Symbol	Parameter	Conditions	25 °C			-40 °C to +125 °C			Unit
			Min	Typ <sup>[1]</sup>	Max	Min	Max (85 °C)	Max (125 °C)	
t <sub>en</sub>	enable time	n $\bar{E}$ to nZ or nY; see <a href="#">Figure 16</a>							
		V <sub>CC</sub> = 1.4 V to 1.6 V	-	27	41	-	44	48	ns
		V <sub>CC</sub> = 1.65 V to 1.95 V	-	23	35	-	37	40	ns
		V <sub>CC</sub> = 2.3 V to 2.7 V	-	17	26	-	28	31	ns
		V <sub>CC</sub> = 2.7 V to 3.6 V	-	14	24	-	25	27	ns
		V <sub>CC</sub> = 3.6 V to 4.3 V	-	14	24	-	25	27	ns
t <sub>dis</sub>	disable time	n $\bar{E}$ to nZ or nY; see <a href="#">Figure 16</a>							
		V <sub>CC</sub> = 1.4 V to 1.6 V	-	9	17	-	19	21	ns
		V <sub>CC</sub> = 1.65 V to 1.95 V	-	7	13	-	14	15	ns
		V <sub>CC</sub> = 2.3 V to 2.7 V	-	4	8	-	9	10	ns
		V <sub>CC</sub> = 2.7 V to 3.6 V	-	3	7	-	8	9	ns
		V <sub>CC</sub> = 3.6 V to 4.3 V	-	3	7	-	8	9	ns

[1] Typical values are measured at T<sub>amb</sub> = 25 °C and V<sub>CC</sub> = 1.5 V, 1.8 V, 2.5 V, 3.3 V and 4.3 V respectively.

**12.1 Waveform and test circuits**

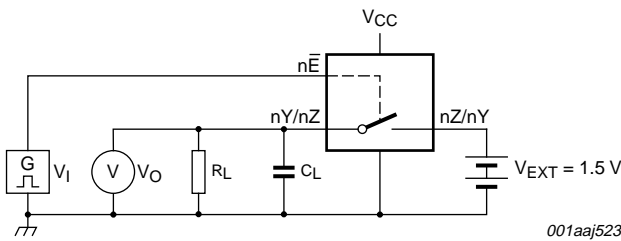


Measurement points are given in [Table 10](#).  
 Logic level:  $V_{OH}$  is the typical output voltage that occurs with the output load.

**Fig 16. Enable and disable times**

**Table 10. Measurement points**

Supply voltage	Input	Output
$V_{CC}$	$V_M$	$V_X$
1.4 V to 4.3 V	$0.5V_{CC}$	$0.9V_{OH}$



Test data is given in [Table 11](#).  
 Definitions test circuit:  
 $R_L$  = Load resistance.  
 $C_L$  = Load capacitance including jig and probe capacitance.  
 $V_{EXT}$  = External voltage for measuring switching times.

**Fig 17. Load circuit for switching times**

**Table 11. Test data**

Supply voltage	Input		Load	
$V_{CC}$	$V_I$	$t_r, t_f$	$C_L$	$R_L$
1.4 V to 4.3 V	$V_{CC}$	$\leq 2.5 \text{ ns}$	35 pF	50 $\Omega$

**12.2 Additional dynamic characteristics**

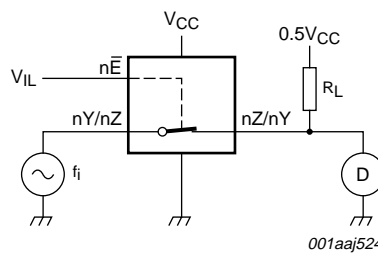
**Table 12. Additional dynamic characteristics**

At recommended operating conditions; voltages are referenced to GND (ground = 0 V);  $V_I = GND$  or  $V_{CC}$  (unless otherwise specified);  $t_r = t_f \leq 2.5$  ns.

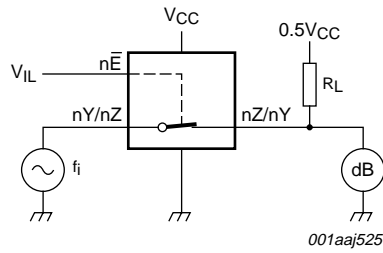
Symbol	Parameter	Conditions	25 °C			Unit
			Min	Typ	Max	
THD	total harmonic distortion	$f_i = 20$ Hz to 20 kHz; $R_L = 32 \Omega$ ; see <a href="#">Figure 18</a> <sup>[1]</sup>				
		$V_{CC} = 1.4$ V; $V_I = 1$ V (p-p)	-	0.15	-	%
		$V_{CC} = 1.65$ V; $V_I = 1.2$ V (p-p)	-	0.10	-	%
		$V_{CC} = 2.3$ V; $V_I = 1.5$ V (p-p)	-	0.02	-	%
		$V_{CC} = 2.7$ V; $V_I = 2$ V (p-p)	-	0.02	-	%
		$V_{CC} = 4.3$ V; $V_I = 2$ V (p-p)	-	0.02	-	%
$f_{(-3dB)}$	-3 dB frequency response	$R_L = 50 \Omega$ ; see <a href="#">Figure 19</a> <sup>[1]</sup>				
		$V_{CC} = 1.4$ V to 4.3 V	-	60	-	MHz
$\alpha_{iso}$	isolation (OFF-state)	$f_i = 100$ kHz; $R_L = 50 \Omega$ ; see <a href="#">Figure 20</a> <sup>[1]</sup>				
		$V_{CC} = 1.4$ V to 4.3 V	-	-90	-	dB
$V_{ct}$	crosstalk voltage	between digital inputs and switch; $f_i = 1$ MHz; $C_L = 50$ pF; $R_L = 50 \Omega$ ; see <a href="#">Figure 21</a>				
		$V_{CC} = 1.4$ V to 3.6 V	-	0.2	-	V
		$V_{CC} = 3.6$ V to 4.3 V	-	0.2	-	V
Xtalk	crosstalk	between switches; <sup>[1]</sup>				
		$f_i = 100$ kHz; $R_L = 50 \Omega$ ; see <a href="#">Figure 22</a>				
		$V_{CC} = 1.4$ V to 4.3 V	-	-90	-	dB
$Q_{inj}$	charge injection	$f_i = 1$ MHz; $C_L = 0.1$ nF; $R_L = 1$ M $\Omega$ ; $V_{gen} = 0$ V; $R_{gen} = 0 \Omega$ ; see <a href="#">Figure 23</a>				
		$V_{CC} = 1.5$ V	-	3	-	pC
		$V_{CC} = 1.8$ V	-	3	-	pC
		$V_{CC} = 2.5$ V	-	3	-	pC
		$V_{CC} = 3.3$ V	-	3	-	pC
			-	6	-	pC

[1]  $f_i$  is biased at  $0.5V_{CC}$ .

**13. Test circuits**

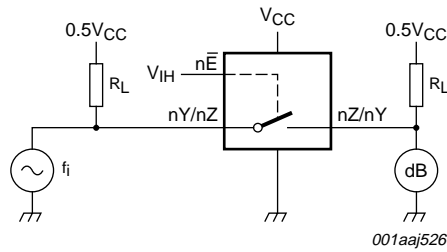


**Fig 18. Test circuit for measuring total harmonic distortion**



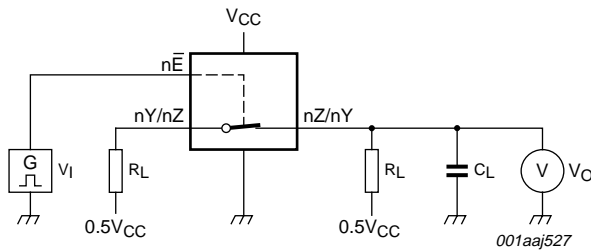
Adjust  $f_i$  voltage to obtain 0 dBm level at output. Increase  $f_i$  frequency until dB meter reads -3 dB.

**Fig 19. Test circuit for measuring the frequency response when channel is in ON-state**

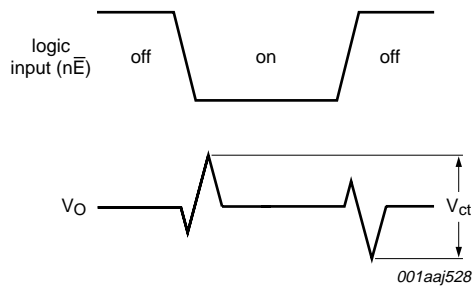


Adjust  $f_i$  voltage to obtain 0 dBm level at input.

**Fig 20. Test circuit for measuring isolation (OFF-state)**

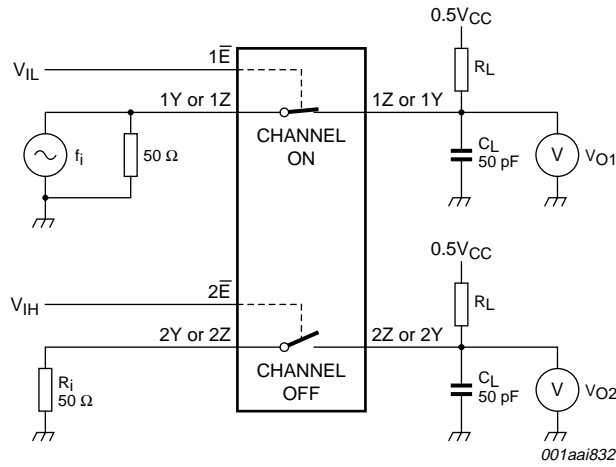


a. Test circuit



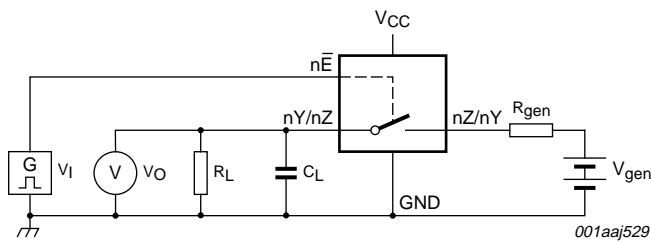
b. input and output pulse definitions

**Fig 21. Test circuit for measuring crosstalk voltage between digital inputs and switch**

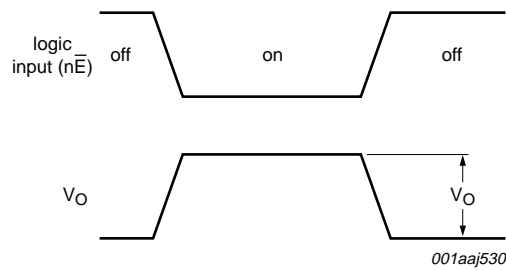


$20 \log_{10} (V_{O2} / V_{O1})$  or  $20 \log_{10} (V_{O1} / V_{O2})$ .

Fig 22. Test circuit for measuring crosstalk between switches



a. Test circuit



b. Input and output pulse definitions

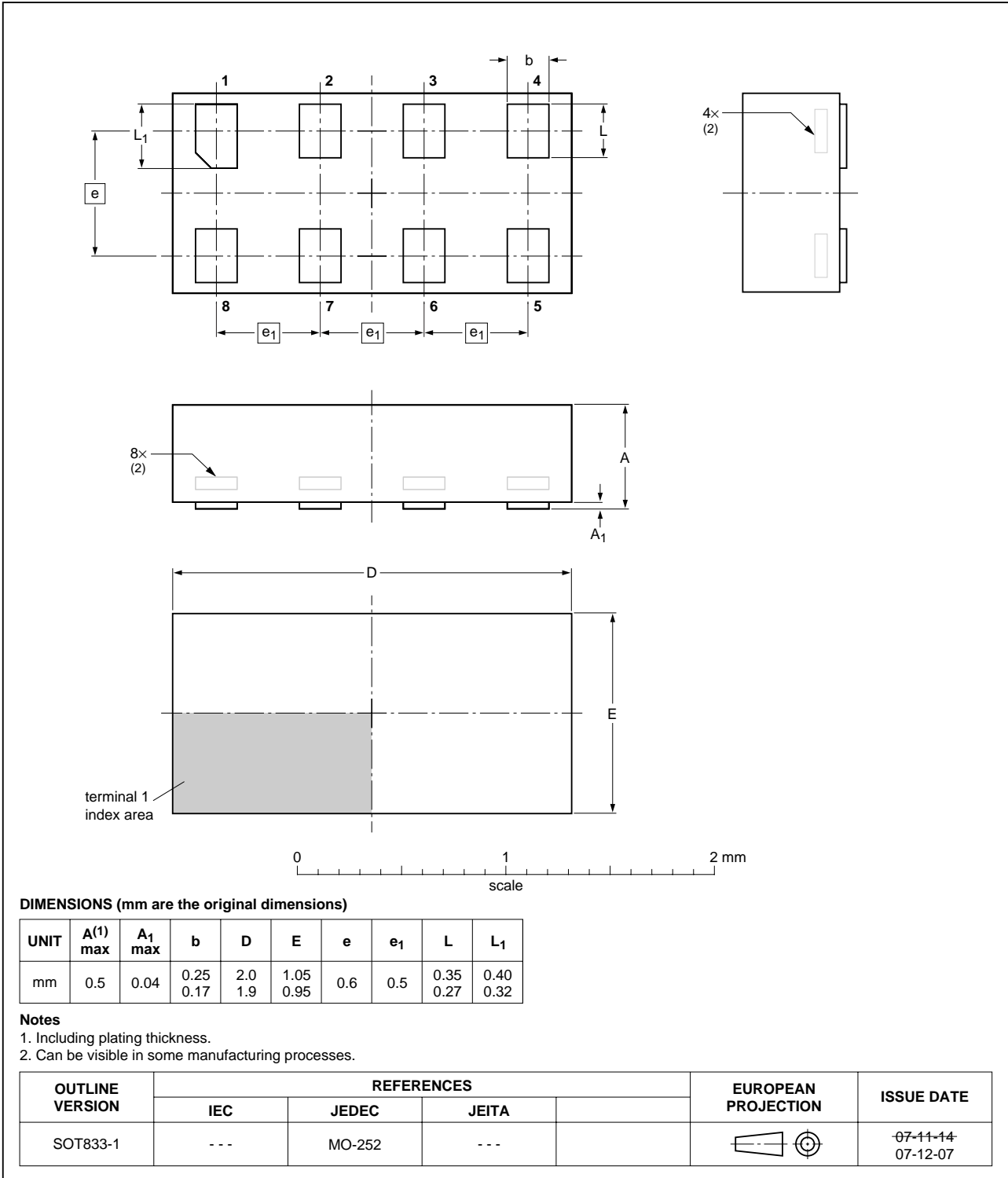
- Definition:  $Q_{inj} = \Delta V_O \times C_L$ .
- $\Delta V_O$  = output voltage variation.
- $R_{gen}$  = generator resistance.
- $V_{gen}$  = generator voltage.

Fig 23. Test circuit for measuring charge injection

**14. Package outline**

XSON8: plastic extremely thin small outline package; no leads; 8 terminals; body 1 x 1.95 x 0.5 mm

SOT833-1



**Fig 24. Package outline SOT833-1 (XSON8)**

XSON8U: plastic extremely thin small outline package; no leads;  
8 terminals; UTLP based; body 3 x 2 x 0.5 mm

SOT996-2

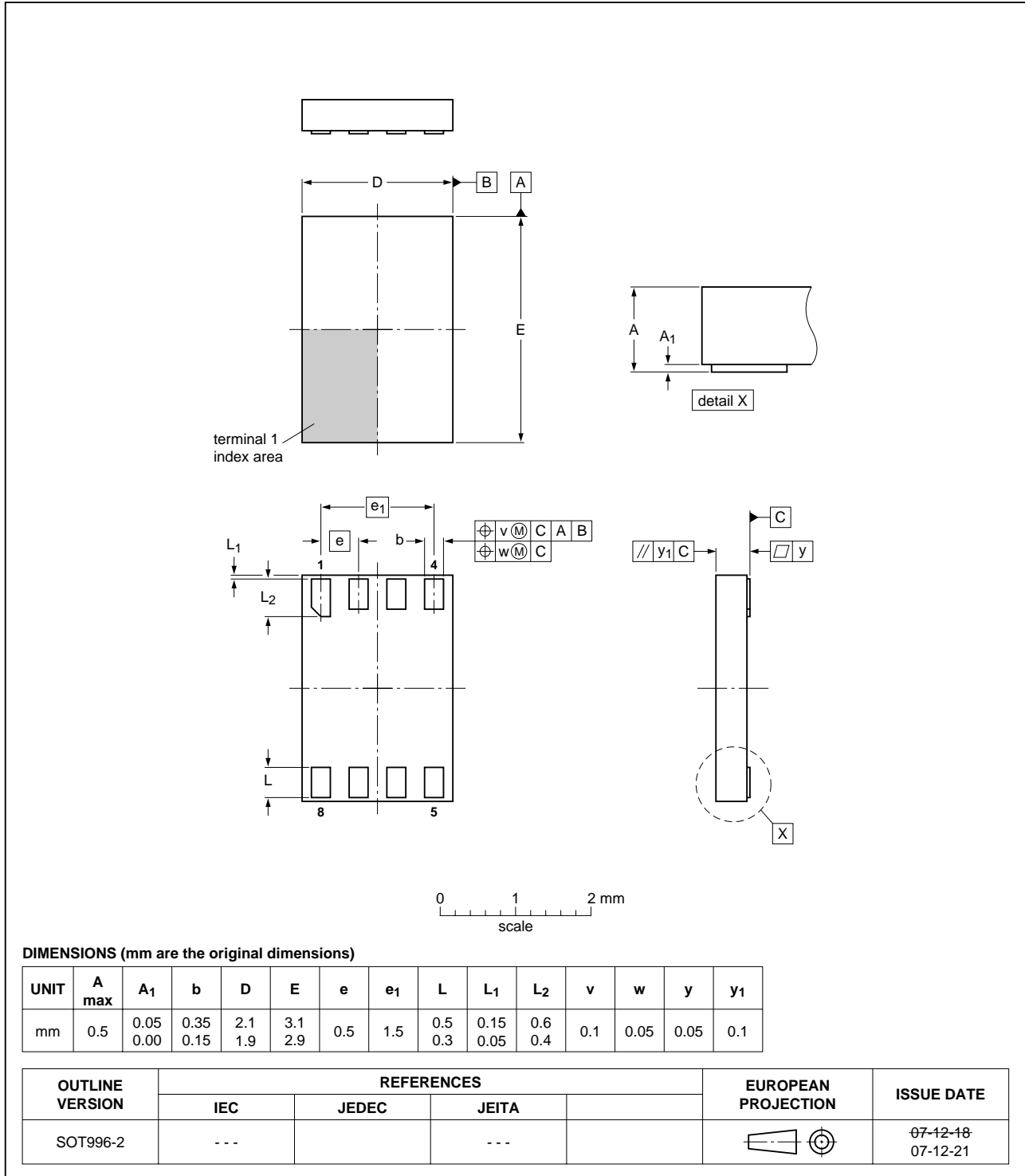
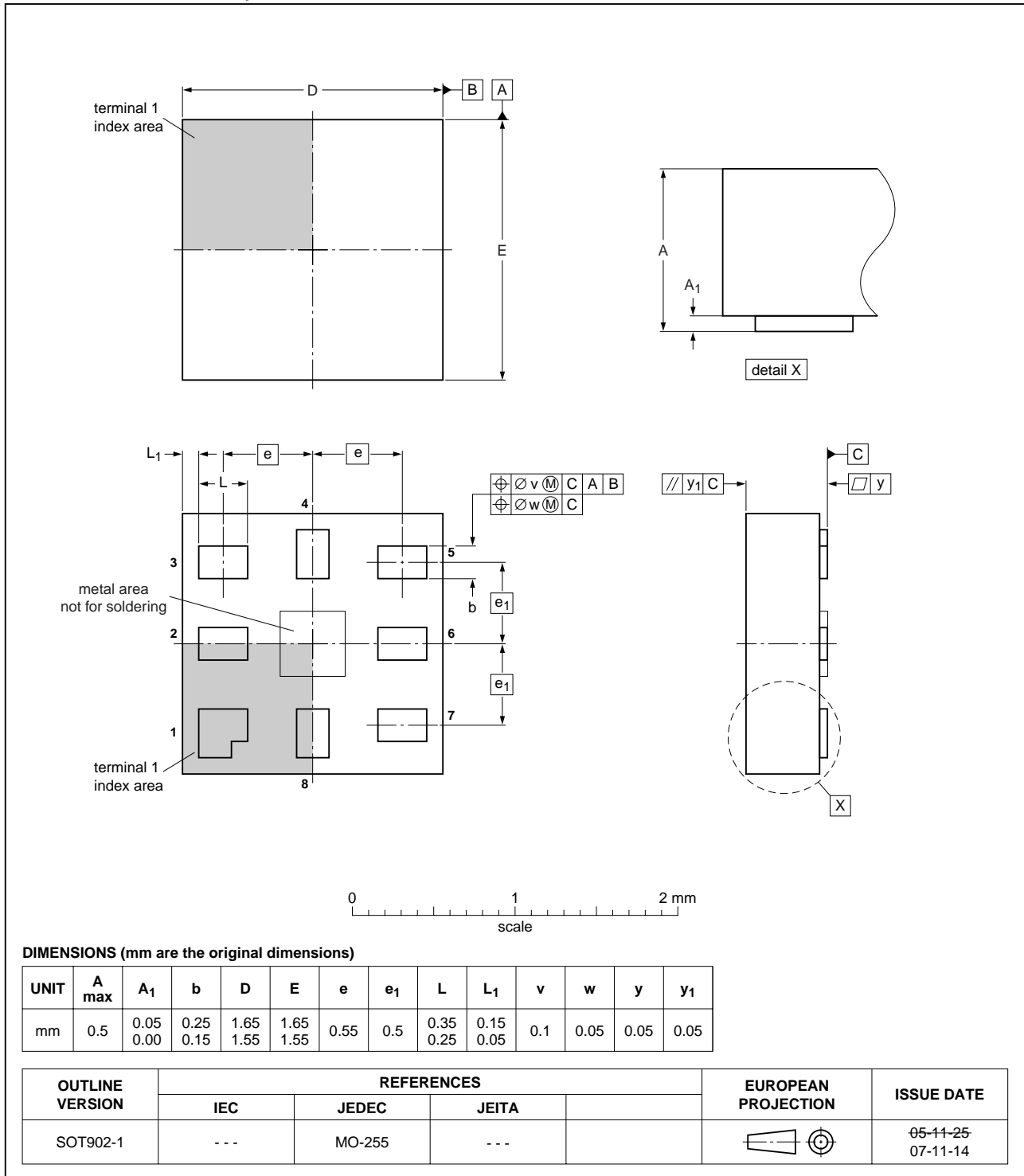


Fig 25. Package outline SOT996-2 (XSON8U)

**XQFN8U: plastic extremely thin quad flat package; no leads; 8 terminals; UTLP based; body 1.6 x 1.6 x 0.5 mm**

**SOT902-1**



**Fig 26. Package outline SOT902-1 (XQFN8U)**

## 15. Abbreviations

Table 13. Abbreviations

Acronym	Description
CDM	Charged Device Model
CMOS	Complementary Metal Oxide Semiconductor
ESD	ElectroStatic Discharge
HBM	Human Body Model
MM	Machine Model
TTL	Transistor-Transistor Logic

## 16. Revision history

Table 14. Revision history

Document ID	Release date	Data sheet status	Change notice	Supersedes
NX3L2G384_3	20090828	Product data sheet	-	NX3L2G384_2
Modifications:				
				<ul style="list-style-type: none"><li>• <a href="#">Figure 6 “Test circuit for measuring OFF-state leakage current”</a> updated.</li><li>• <a href="#">Table 8 “ON resistance”</a>: <math>R_{ON(flat)}</math> values for <math>V_{CC} = 4.3</math> V updated.</li></ul>
NX3L2G384_2	20090415	Product data sheet	-	NX3L2G384_1
NX3L2G384_1	20080918	Product data sheet	-	-

## 17. Legal information

### 17.1 Data sheet status

Document status <sup>[1][2]</sup>	Product status <sup>[3]</sup>	Definition
Objective [short] data sheet	Development	This document contains data from the objective specification for product development.
Preliminary [short] data sheet	Qualification	This document contains data from the preliminary specification.
Product [short] data sheet	Production	This document contains the product specification.

[1] Please consult the most recently issued document before initiating or completing a design.

[2] The term 'short data sheet' is explained in section "Definitions".

[3] The product status of device(s) described in this document may have changed since this document was published and may differ in case of multiple devices. The latest product status information is available on the Internet at URL <http://www.nxp.com>.

### 17.2 Definitions

**Draft** — The document is a draft version only. The content is still under internal review and subject to formal approval, which may result in modifications or additions. NXP Semiconductors does not give any representations or warranties as to the accuracy or completeness of information included herein and shall have no liability for the consequences of use of such information.

**Short data sheet** — A short data sheet is an extract from a full data sheet with the same product type number(s) and title. A short data sheet is intended for quick reference only and should not be relied upon to contain detailed and full information. For detailed and full information see the relevant full data sheet, which is available on request via the local NXP Semiconductors sales office. In case of any inconsistency or conflict with the short data sheet, the full data sheet shall prevail.

### 17.3 Disclaimers

**General** — Information in this document is believed to be accurate and reliable. However, NXP Semiconductors does not give any representations or warranties, expressed or implied, as to the accuracy or completeness of such information and shall have no liability for the consequences of use of such information.

**Right to make changes** — NXP Semiconductors reserves the right to make changes to information published in this document, including without limitation specifications and product descriptions, at any time and without notice. This document supersedes and replaces all information supplied prior to the publication hereof.

**Suitability for use** — NXP Semiconductors products are not designed, authorized or warranted to be suitable for use in medical, military, aircraft, space or life support equipment, nor in applications where failure or malfunction of an NXP Semiconductors product can reasonably be expected to result in personal injury, death or severe property or environmental

damage. NXP Semiconductors accepts no liability for inclusion and/or use of NXP Semiconductors products in such equipment or applications and therefore such inclusion and/or use is at the customer's own risk.

**Applications** — Applications that are described herein for any of these products are for illustrative purposes only. NXP Semiconductors makes no representation or warranty that such applications will be suitable for the specified use without further testing or modification.

**Limiting values** — Stress above one or more limiting values (as defined in the Absolute Maximum Ratings System of IEC 60134) may cause permanent damage to the device. Limiting values are stress ratings only and operation of the device at these or any other conditions above those given in the Characteristics sections of this document is not implied. Exposure to limiting values for extended periods may affect device reliability.

**Terms and conditions of sale** — NXP Semiconductors products are sold subject to the general terms and conditions of commercial sale, as published at <http://www.nxp.com/profile/terms>, including those pertaining to warranty, intellectual property rights infringement and limitation of liability, unless explicitly otherwise agreed to in writing by NXP Semiconductors. In case of any inconsistency or conflict between information in this document and such terms and conditions, the latter will prevail.

**No offer to sell or license** — Nothing in this document may be interpreted or construed as an offer to sell products that is open for acceptance or the grant, conveyance or implication of any license under any copyrights, patents or other industrial or intellectual property rights.

**Export control** — This document as well as the item(s) described herein may be subject to export control regulations. Export might require a prior authorization from national authorities.

### 17.4 Trademarks

Notice: All referenced brands, product names, service names and trademarks are the property of their respective owners.

## 18. Contact information

For more information, please visit: <http://www.nxp.com>

For sales office addresses, please send an email to: [salesaddresses@nxp.com](mailto:salesaddresses@nxp.com)

## 19. Contents

<b>1</b>	<b>General description</b> . . . . .	<b>1</b>
<b>2</b>	<b>Features</b> . . . . .	<b>1</b>
<b>3</b>	<b>Applications</b> . . . . .	<b>1</b>
<b>4</b>	<b>Ordering information</b> . . . . .	<b>2</b>
<b>5</b>	<b>Marking</b> . . . . .	<b>2</b>
<b>6</b>	<b>Functional diagram</b> . . . . .	<b>2</b>
<b>7</b>	<b>Pinning information</b> . . . . .	<b>3</b>
7.1	Pinning . . . . .	3
7.2	Pin description . . . . .	4
<b>8</b>	<b>Functional description</b> . . . . .	<b>4</b>
<b>9</b>	<b>Limiting values</b> . . . . .	<b>4</b>
<b>10</b>	<b>Recommended operating conditions</b> . . . . .	<b>5</b>
<b>11</b>	<b>Static characteristics</b> . . . . .	<b>5</b>
11.1	Test circuits . . . . .	6
11.2	ON resistance . . . . .	6
11.3	ON resistance test circuit and graphs . . . . .	8
<b>12</b>	<b>Dynamic characteristics</b> . . . . .	<b>10</b>
12.1	Waveform and test circuits . . . . .	11
12.2	Additional dynamic characteristics . . . . .	12
<b>13</b>	<b>Test circuits</b> . . . . .	<b>12</b>
<b>14</b>	<b>Package outline</b> . . . . .	<b>15</b>
<b>15</b>	<b>Abbreviations</b> . . . . .	<b>18</b>
<b>16</b>	<b>Revision history</b> . . . . .	<b>18</b>
<b>17</b>	<b>Legal information</b> . . . . .	<b>19</b>
17.1	Data sheet status . . . . .	19
17.2	Definitions . . . . .	19
17.3	Disclaimers . . . . .	19
17.4	Trademarks . . . . .	19
<b>18</b>	<b>Contact information</b> . . . . .	<b>19</b>
<b>19</b>	<b>Contents</b> . . . . .	<b>20</b>

Please be aware that important notices concerning this document and the product(s) described herein, have been included in section 'Legal information'.



© NXP B.V. 2009.

All rights reserved.

For more information, please visit: <http://www.nxp.com>

For sales office addresses, please send an email to: [salesaddresses@nxp.com](mailto:salesaddresses@nxp.com)

Date of release: 28 August 2009

Document identifier: NX3L2G384\_3