

REVISION RECORD			
LTR	ECO NO:	APPROVED:	DATE:

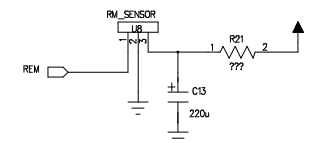
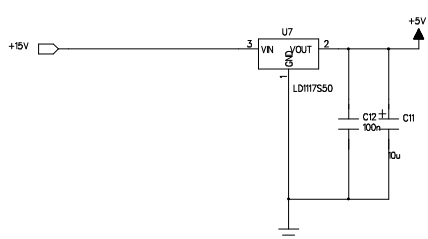
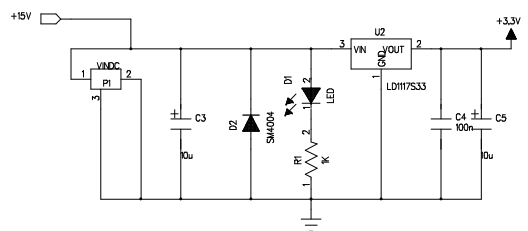
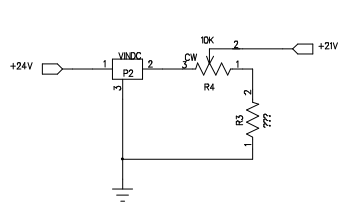

D

D

C

C

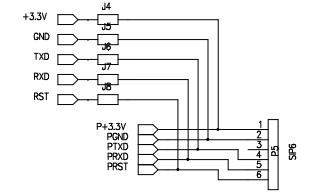
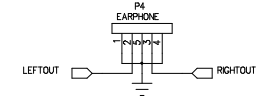
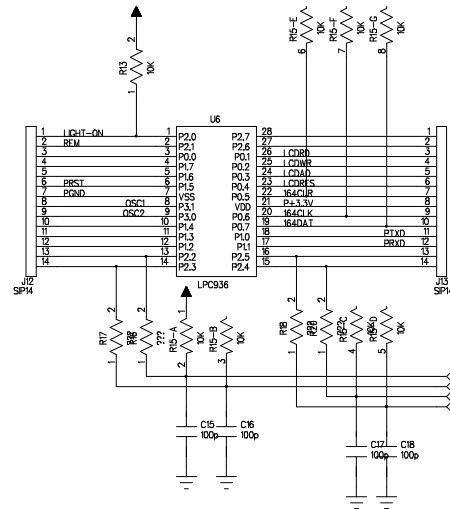
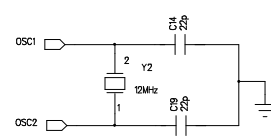
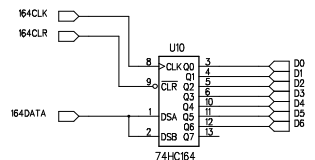
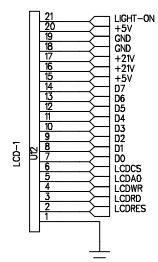

B

B

A

A

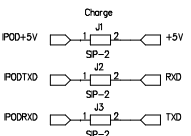
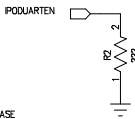
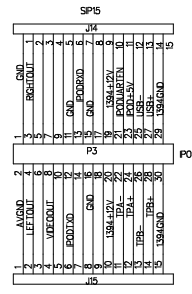
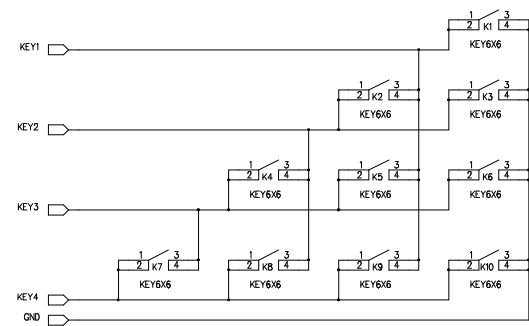

COMPANY:		Philips Semiconductor		
TITLE:		iPod Demo 2.0		
DRAWN:	Allen Lv	DATED:	2006-8-4	
CHECKED:		DATED:		
QUALITY CONTROL:		DATED:		
RELEASED:		DATED:		
SCALE:		CODE:	SIZE:	DRAWING NO:
				REV:
				SHEET: OF