

Rev History		
Date	Rev	Description

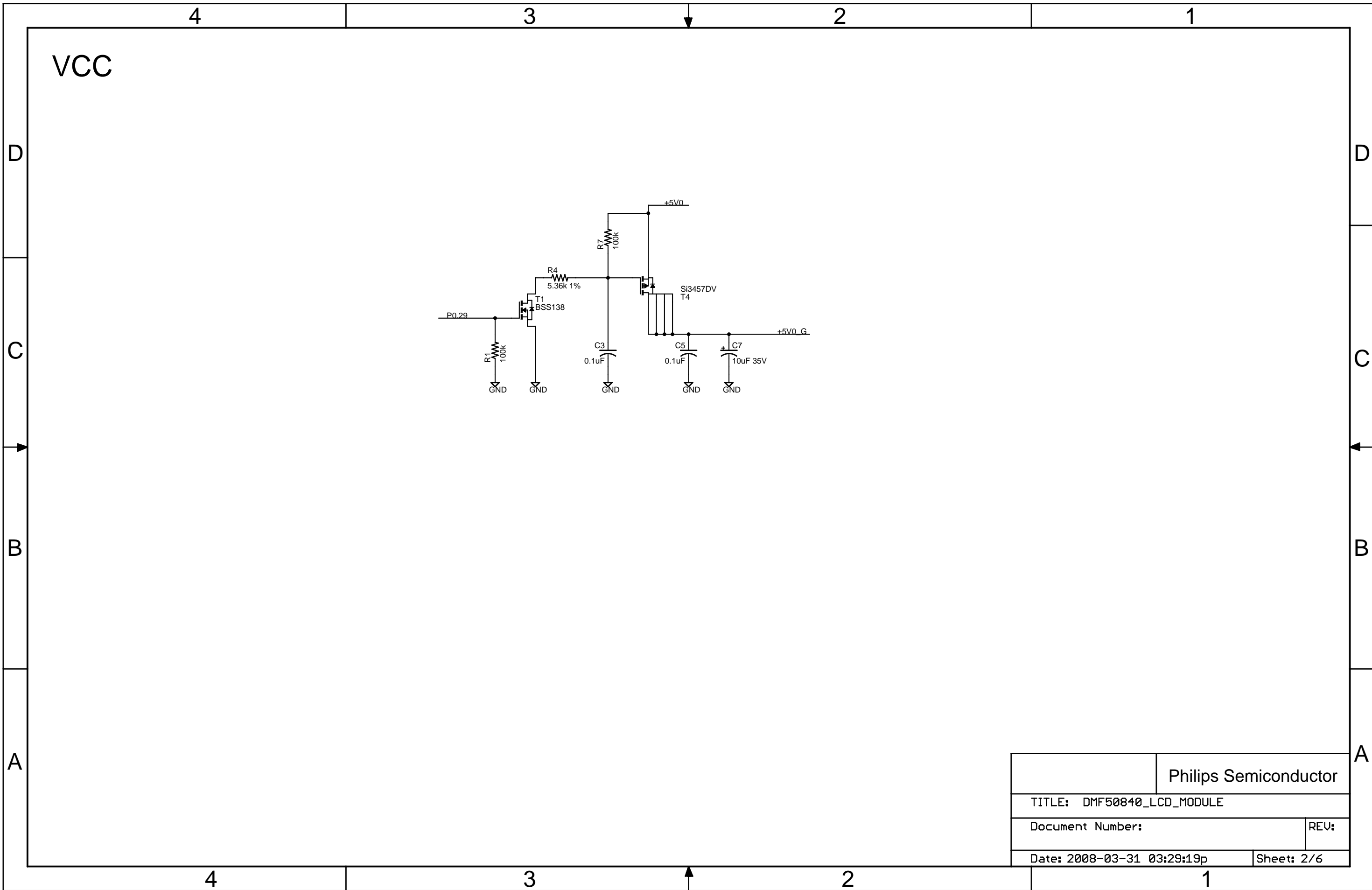

Philips Semiconductor	
TITLE: DMF50840_LCD_MODULE	
Document Number:	REV:
Date: 2008-03-31 03:29:19p	Sheet: 2/6

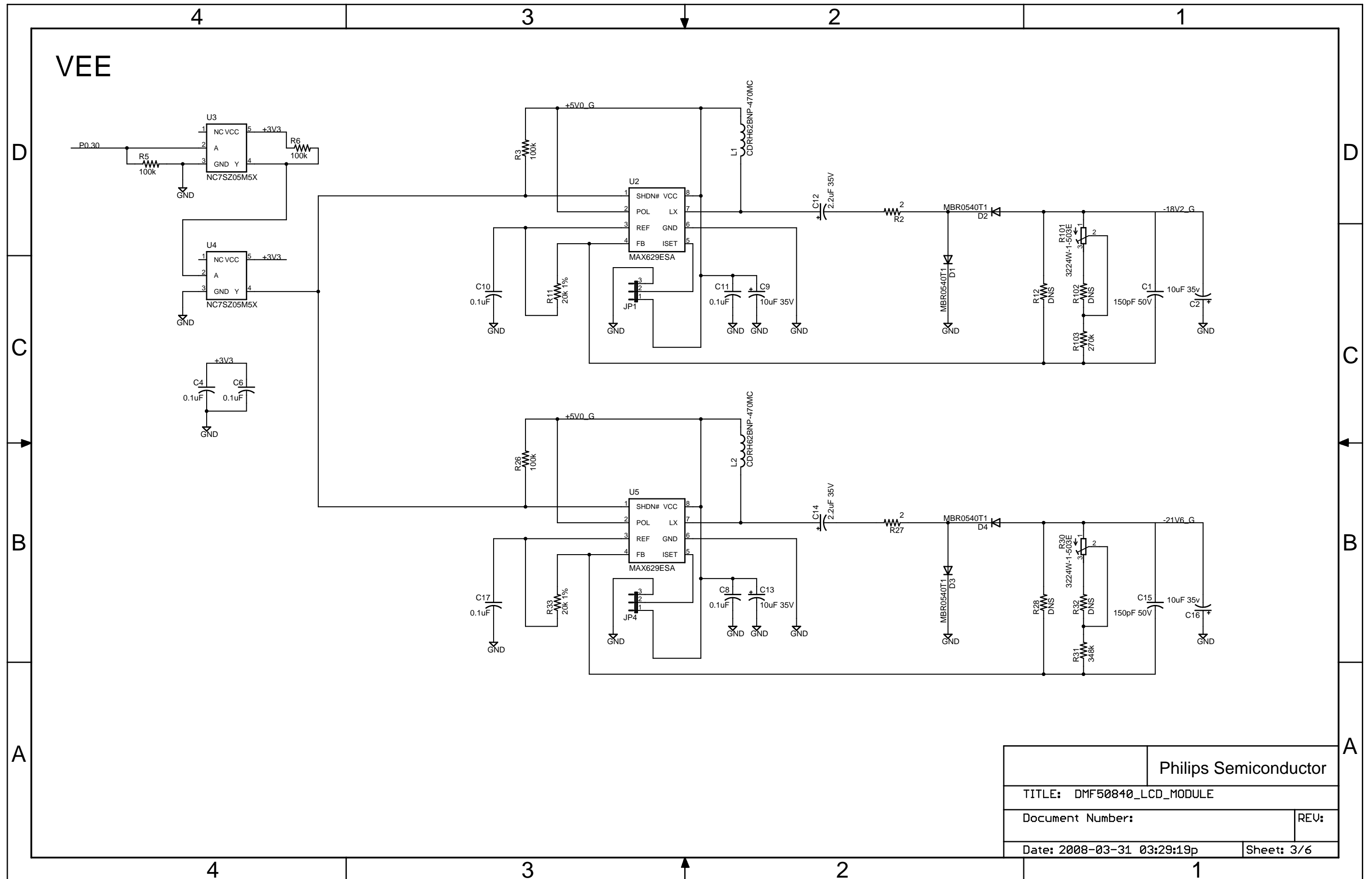

Philips Semiconductor	
TITLE: DMF50840_LCD_MODULE	
Document Number:	REV:
Date: 2008-03-31 03:29:19p	Sheet: 3/6

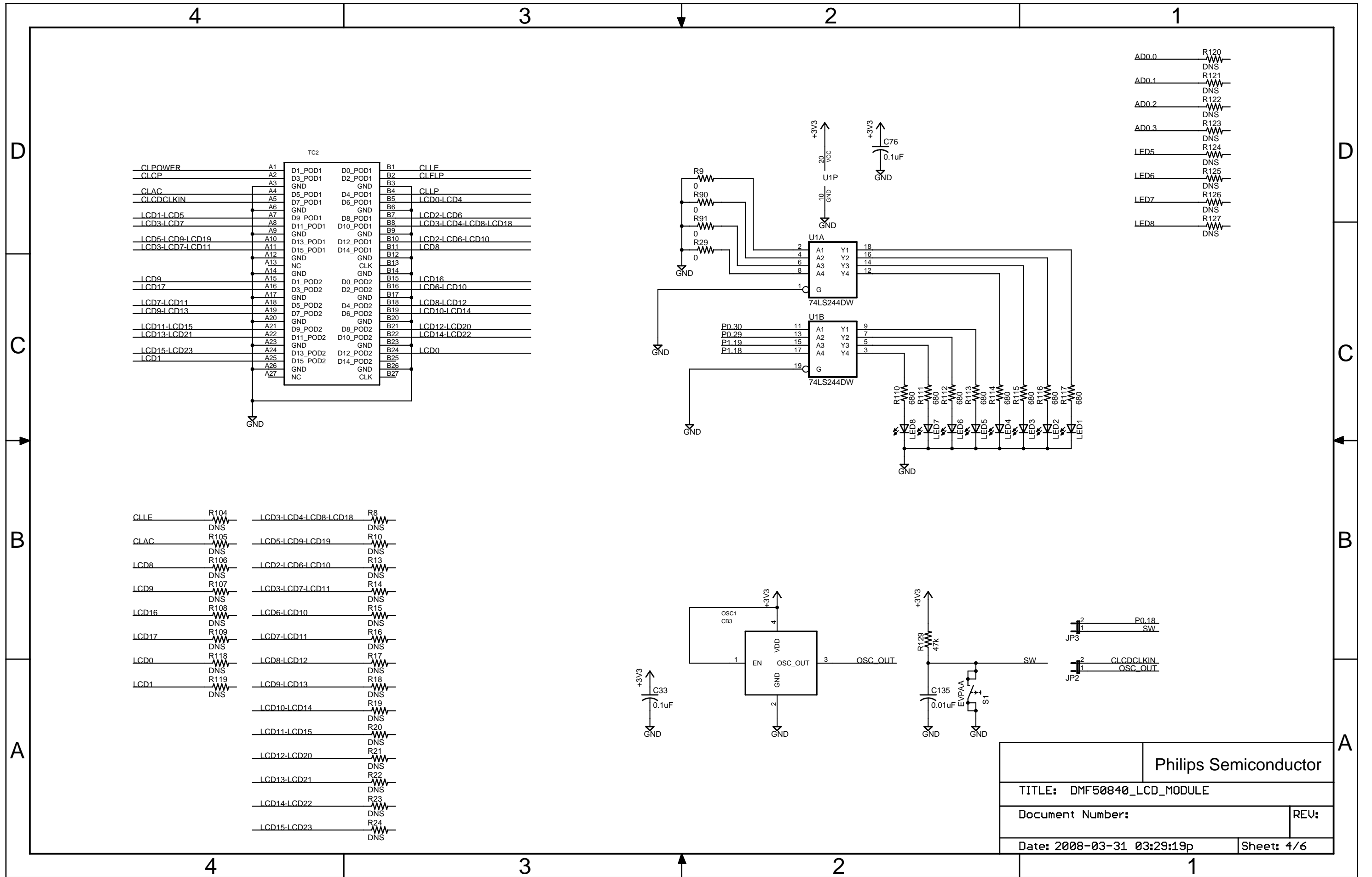

Philips Semiconductor	
TITLE: DMF50840_LCD_MODULE	
Document Number:	REV:
Date: 2008-03-31 03:29:19p	Sheet: 4/6

VIDEO board connectors

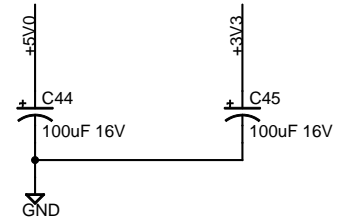
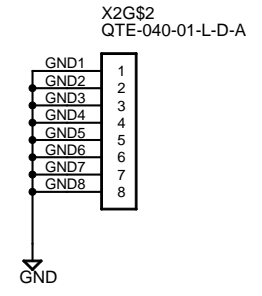
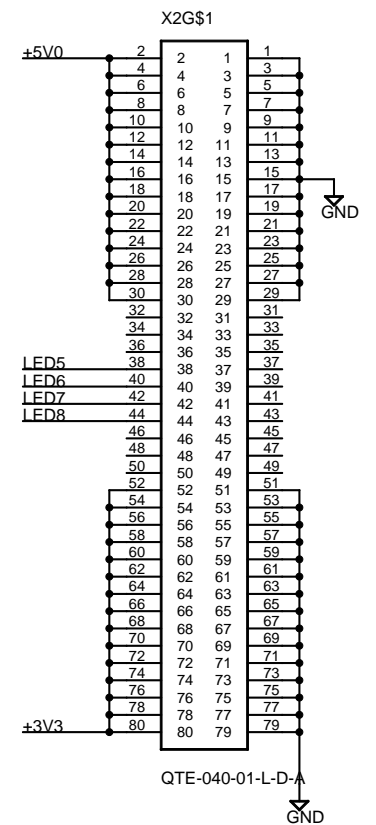
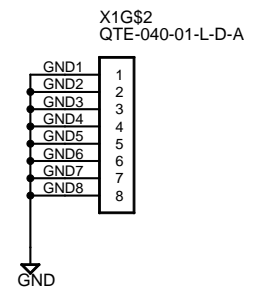
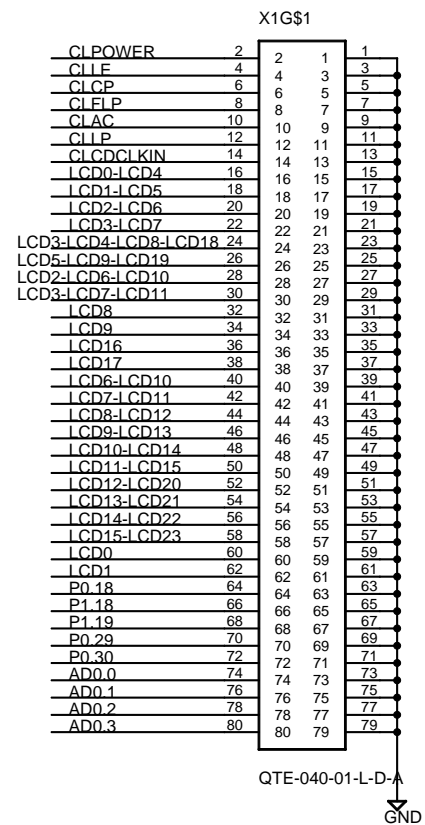

Philips Semiconductor	
TITLE: DMF50840_LCD_MODULE	
Document Number:	REV:
Date: 2008-03-31 03:29:19p	Sheet: 5/6

LCD Connectors

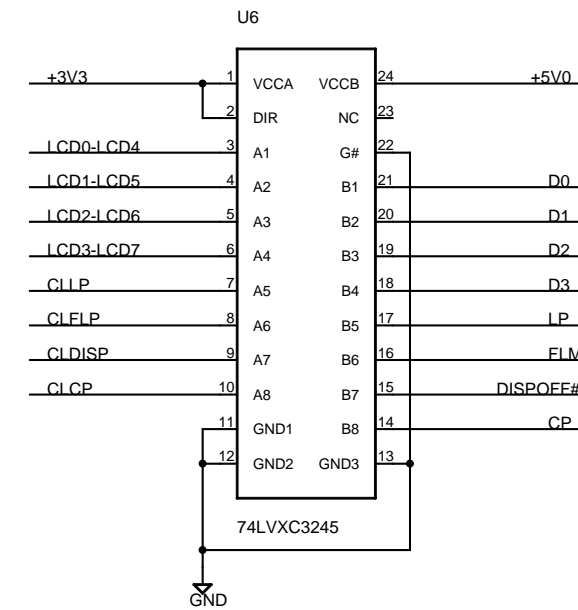
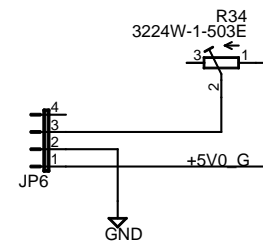
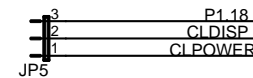
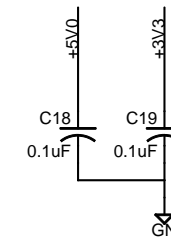
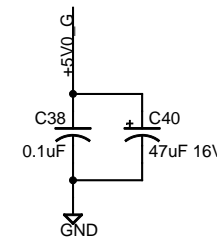
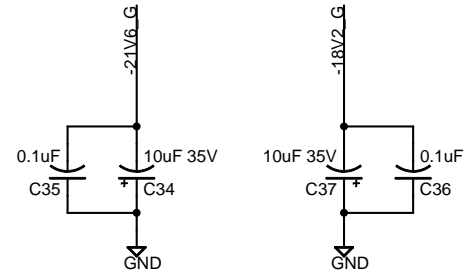
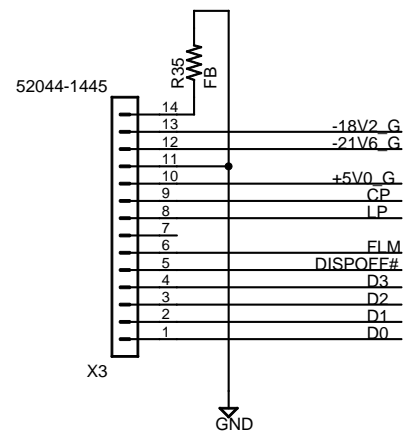

Philips Semiconductor	
TITLE: DMF50840_LCD_MODULE	
Document Number:	REV:
Date: 2008-03-31 03:29:19p	Sheet: 6/6